



## **PRODUCT RANGE**

### **CODE:**

MRV15

### **DESCRIPTION:**

15mm Manual Rad Valve

## **Dimensions**

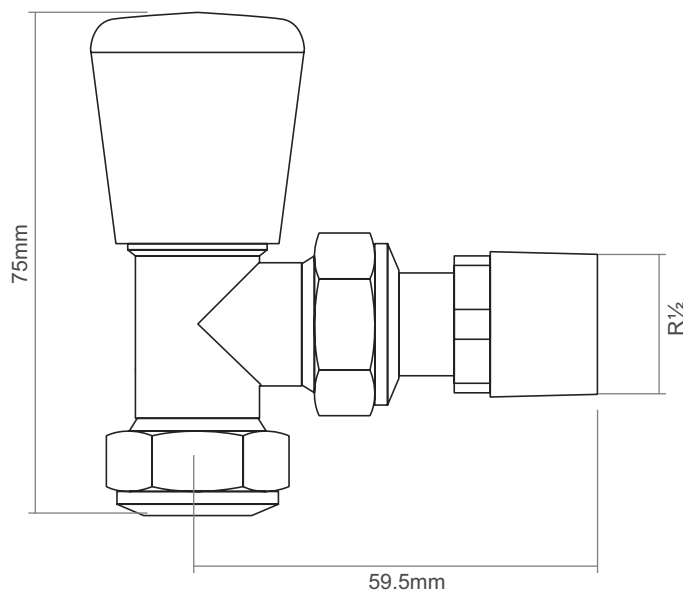

## **Technical Specification**

Max Operating Pressure	10 Bar
Maximum Inlet Temperature	100°